



PD55003-E PD55003S-E

RF power transistor, LdmoST plastic family N-channel enhancement-mode lateral MOSFETs

Features

- Excellent thermal stability
- Common source configuration
- $P_{OUT} = 3W$ with 17dB gain @ 500MHz / 12.5
- New RF plastic package

Description

The PD55003 is a common source N-channel, enhancement-mode lateral Field-Effect RF power transistor. It is designed for high gain, broad band commercial and industrial applications. It operates at 12 V in common source mode at frequencies of up to 1 GHz. PD55003 boasts the excellent gain, linearity and reliability of ST's latest LDMOS technology mounted in the first true SMD plastic RF power package, PowerSO-10RF. PD55003's superior linearity performance makes it an ideal solution for car mobile radio.

The PowerSO-10 plastic package, designed to offer high reliability, is the first ST JEDEC approved, high power SMD package. It has been specially optimized for RF needs and offers excellent RF performances and ease of assembly.

Mounting recommendations are available in www.st.com/rf/ (look for application note AN1294)

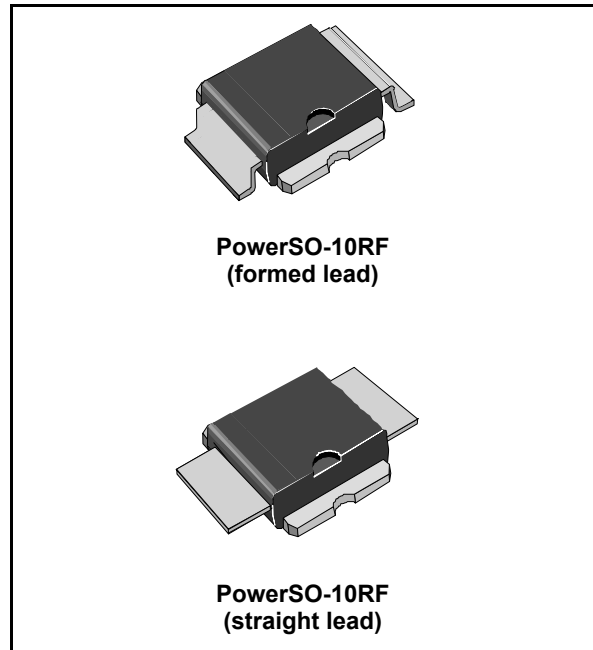

Figure 1. Pin connection

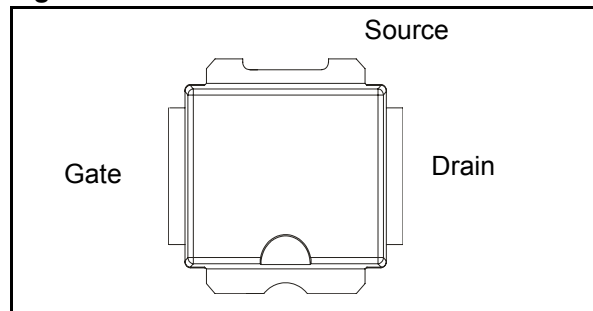

Table 1. Device summary

Order codes	Package	Packaging
PD55003-E	PowerSO-10RF (formed lead)	Tube
PD55003S-E	PowerSO-10RF (straight lead)	Tube
PD55003TR-E	PowerSO-10RF (formed lead)	Tape and reel
PD55003STR-E	PowerSO-10RF (straight lead)	Tape and reel

Contents

1	Electrical data	5
1.1	Maximum ratings	5
1.2	Thermal data	5
2	Electrical characteristics	6
2.1	Static	6
2.2	Dynamic	6
3	Impedance	7
4	Typical performance	8
5	Typical performance (860MHz)	15
6	Test circuit	16
7	Circuit layout	18
8	Common source s-parameter	19
8.1	PD55003 (VDS = 12.5V IDS = 0.15A)	19
8.2	PD55003 (VDS = 12.5V IDS = 0.8A)	20
8.3	PD55003 (VDS = 12.5V IDS = 1.5A)	21
8.4	PD55003S (VDS = 12.5V IDS = 0.15A)	22
8.5	PD55003S (VDS = 12.5V IDS = 0.8A)	23
8.6	PD55003S (VDS = 12.5V IDS = 1.5A)	24
9	Package mechanical data	25
10	Revision history	30

List of tables

Table 1.	Device summary	1
Table 2.	Absolute maximum ratings (TCASE = 25°C)	5
Table 3.	Thermal data	5
Table 4.	Static	6
Table 5.	Dynamic	6
Table 6.	Impedance data	7
Table 7.	Drain efficiency vs supply voltage	11
Table 8.	Test circuit component part list	16
Table 9.	S-parameter	19
Table 10.	S-parameter	20
Table 11.	S-parameter	21
Table 12.	S-parameter	22
Table 13.	S-parameter	23
Table 14.	S-parameter	24
Table 15.	PowerSO-10RF formed lead (Gull Wing) mechanical data	26
Table 16.	PowerSO-10RF straight lead mechanical data	27
Table 17.	Revision history	30

List of figures

Figure 1.	Pin connection	1
Figure 2.	Current conventions	7
Figure 3.	Capacitance Vs. drain voltage	8
Figure 4.	Drain current Vs. gate-source voltage	8
Figure 5.	Gate-source voltage Vs. case temperature	8
Figure 6.	Output power Vs. input power	9
Figure 7.	Output power Vs. input power	9
Figure 8.	Drain efficiency Vs. output power	9
Figure 9.	Drain efficiency Vs. output power	9
Figure 10.	Power gain Vs. output power	10
Figure 11.	Return loss Vs. output power	10
Figure 12.	Output power Vs. bias current	10
Figure 13.	Drain efficiency Vs. bias current	10
Figure 14.	Output power Vs. supply voltage	11
Figure 15.	Output power Vs. gate voltage	11
Figure 16.	Output power Vs. input power	12
Figure 17.	Output power Vs. input power	12
Figure 18.	Drain efficiency Vs. output power	12
Figure 19.	Drain efficiency Vs. output power	12
Figure 20.	Power gain Vs. output power	13
Figure 21.	Return loss Vs. output power	13
Figure 22.	Output power Vs. bias current	13
Figure 23.	Drain efficiency Vs. bias current	13
Figure 24.	Output power Vs. supply voltage	14
Figure 25.	Drain efficiency Vs. supply voltage	14
Figure 26.	Output power Vs. gate voltage	14
Figure 27.	Output power Vs. input power	15
Figure 28.	Drain efficiency Vs. output power	15
Figure 29.	Input return loss Vs. output power	15
Figure 30.	Test circuit schematic	16
Figure 31.	Test fixture component layout	18
Figure 32.	Test circuit photomaster	18
Figure 33.	Package dimensions.	26
Figure 34.	Package dimensions.	27
Figure 35.	Tube information.	28
Figure 36.	Reel information	29

1 Electrical data

1.1 Maximum ratings

Table 2. Absolute maximum ratings ($T_{CASE} = 25^{\circ}C$)

Symbol	Parameter	Value	Unit
$V_{(BR)DSS}$	Drain-source voltage	40	V
V_{GS}	Gate-source voltage	± 20	V
I_D	Drain current	2.5	A
P_{DISS}	Power dissipation (@ $T_C = 70^{\circ}C$)	31.7	W
T_J	Max. operating junction temperature	165	$^{\circ}C$
T_{STG}	Storage temperature	-65 to +150	$^{\circ}C$

1.2 Thermal data

Table 3. Thermal data

Symbol	Parameter	Value	Unit
R_{thJC}	Junction - case thermal resistance	3.0	$^{\circ}C/W$

2 Electrical characteristics

$$T_{\text{CASE}} = +25\text{ }^{\circ}\text{C}$$

2.1 Static

Table 4. Static

Symbol	Test conditions		Min	Typ	Max	Unit
I_{DSS}	$V_{\text{GS}} = 0\text{V}$	$V_{\text{DS}} = 28\text{V}$			1	μA
I_{GSS}	$V_{\text{GS}} = 20\text{V}$	$V_{\text{DS}} = 0\text{V}$			1	μA
$V_{\text{GS(Q)}}$	$V_{\text{DS}} = 10\text{V}$	$I_{\text{D}} = 50\text{mA}$	2.0		5.0	V
$R_{\text{DS(ON)}}$	$V_{\text{GS}} = 10\text{V}$	$I_{\text{D}} = 1\text{A}$			0.75	Ω
g_{FS}	$V_{\text{DS}} = 10\text{V}$	$I_{\text{D}} = 1\text{A}$		1.0		mho
C_{ISS}	$V_{\text{GS}} = 0\text{V}$	$V_{\text{DS}} = 12.5\text{V}$		36		pF
C_{OSS}	$V_{\text{GS}} = 0\text{V}$	$V_{\text{DS}} = 12.5\text{V}$		24		pF
C_{RSS}	$V_{\text{GS}} = 0\text{V}$	$V_{\text{DS}} = 12.5\text{V}$		2.4		pF

2.2 Dynamic

Table 5. Dynamic

Symbol	Test conditions		Min	Typ	Max	Unit
$P_{1\text{dB}}$	$V_{\text{DD}} = 12.5\text{V}$, $I_{\text{DQ}} = 50\text{mA}$	$f = 500\text{MHz}$	3			W
G_{P}	$V_{\text{DD}} = 12.5\text{V}$, $I_{\text{DQ}} = 50\text{mA}$, $P_{\text{OUT}} = 3\text{W}$	$f = 500\text{MHz}$	14	17		dB
h_{D}	$V_{\text{DD}} = 12.5\text{V}$, $I_{\text{DQ}} = 50\text{mA}$, $P_{\text{OUT}} = 3\text{W}$	$f = 500\text{MHz}$	45	52		%
Load mismatch	$V_{\text{DD}} = 15.5\text{V}$, $I_{\text{DQ}} = 50\text{mA}$, $P_{\text{OUT}} = 3\text{W}$	$f = 500\text{MHz}$ All phase angles	20:1			VSWR

3 Impedance

Figure 2. Current conventions

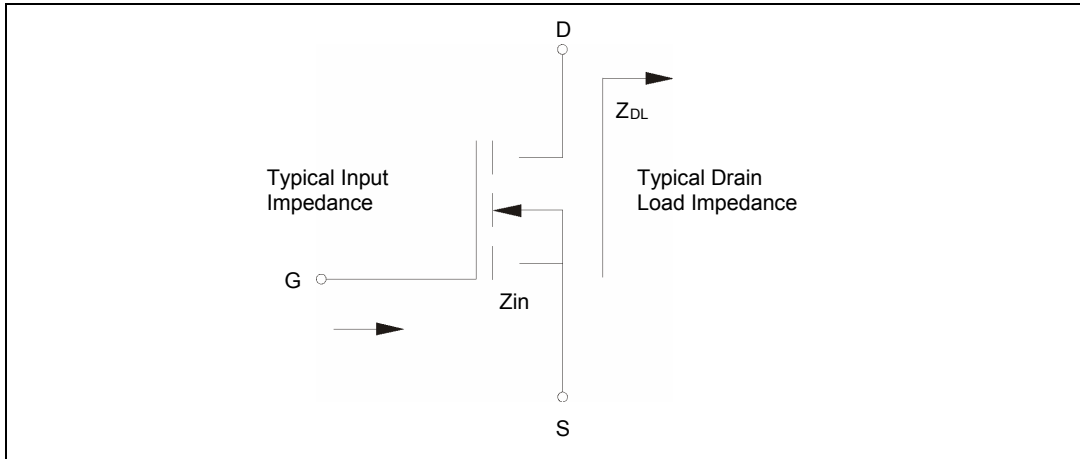

Table 6. Impedance data

PD55003			PD55003S		
Freq. (MHz)	$Z_{IN} (\Omega)$	$Z_{DL} (\Omega)$	Freq. (MHz)	$Z_{IN} (\Omega)$	$Z_{DL} (\Omega)$
520	1.871 - j 1.118	4.779 + j 4.956	520	1.407 - j 3.550	6.557 + j 7.844
500	1.542 - j 3.705	6.842 + j 6.209	500	1.306 - j 5.159	8.351 + j 9.120
480	1.109 - j 1.783	6.789 + j 4.533	480	1.302 - j 6.141	8.994 + j 8.983
860	1.33 + j 1.23	2.93 + j 0.62			

4 Typical performance

Figure 3. Capacitance vs drain voltage

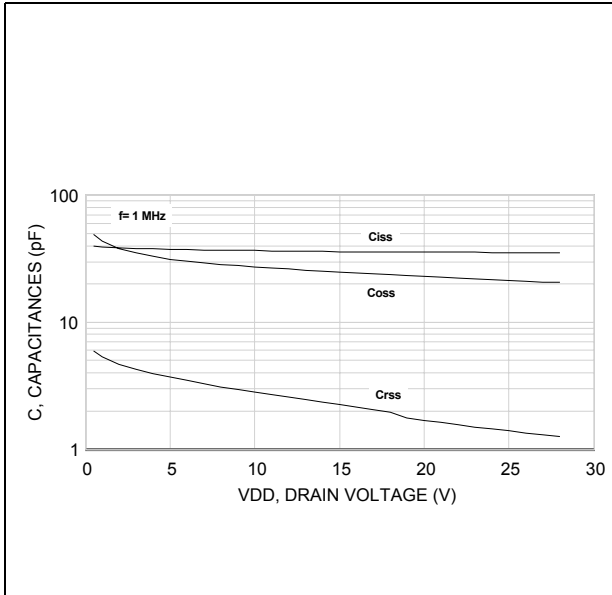

Figure 4. Drain current vs gate-source voltage

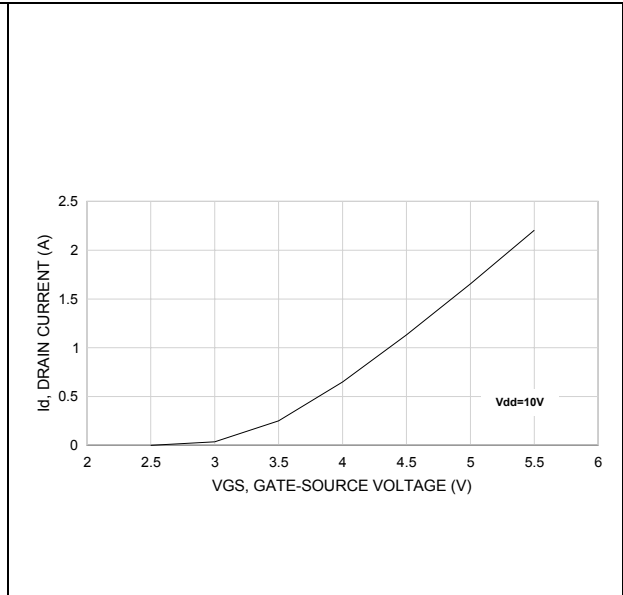
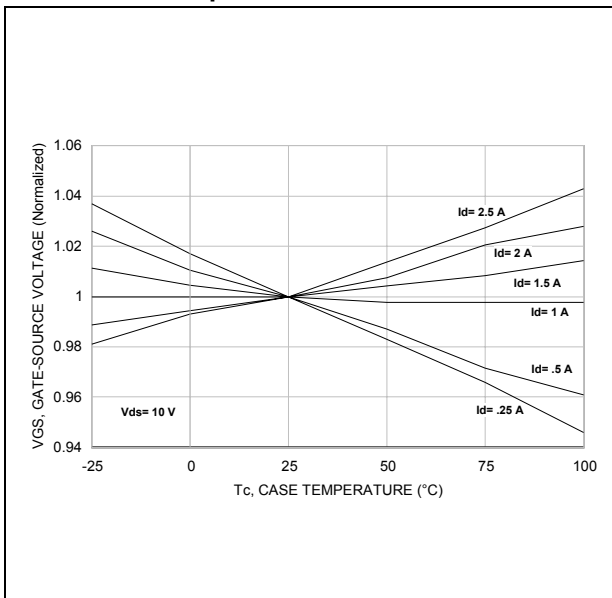

Figure 5. Gate-source voltage vs case temperature



PD55003

Figure 6. Output power vs input power

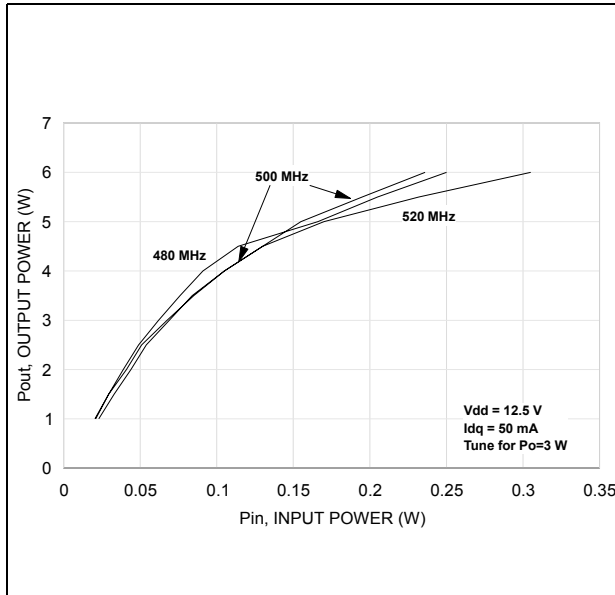

Figure 7. Output power vs input power

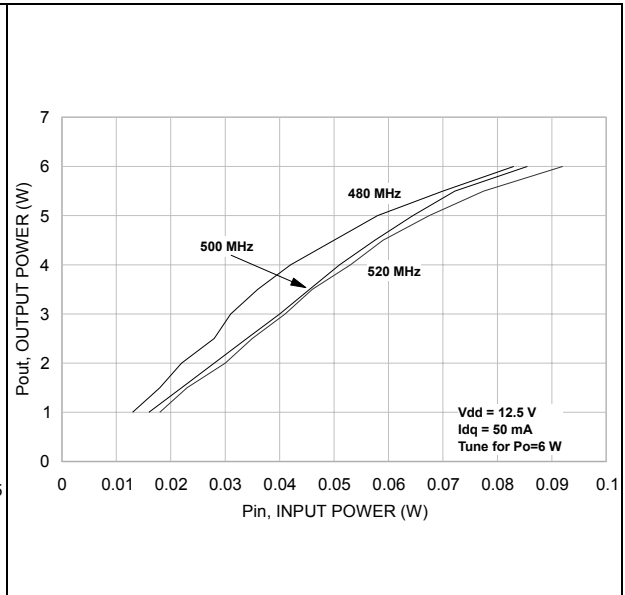

Figure 8. Drain efficiency vs output power

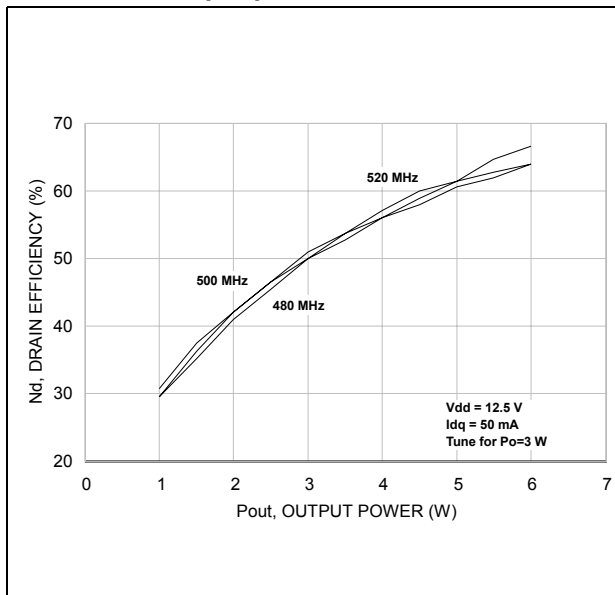
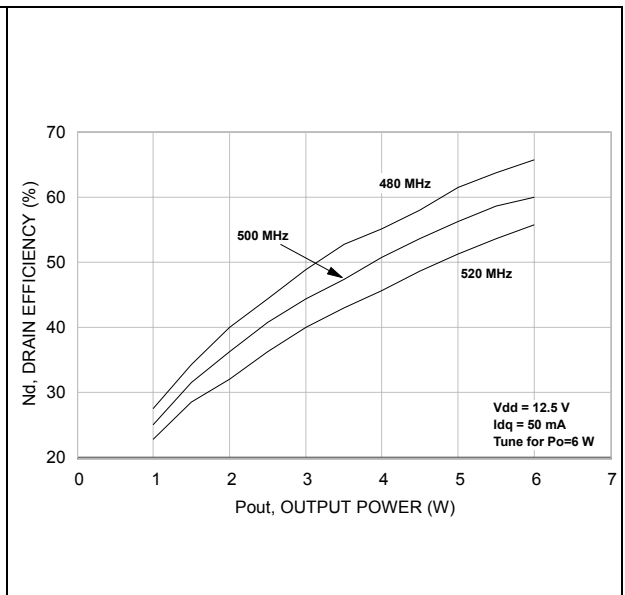

Figure 9. Drain efficiency vs output power



PD55003

Figure 10. Power gain vs output power

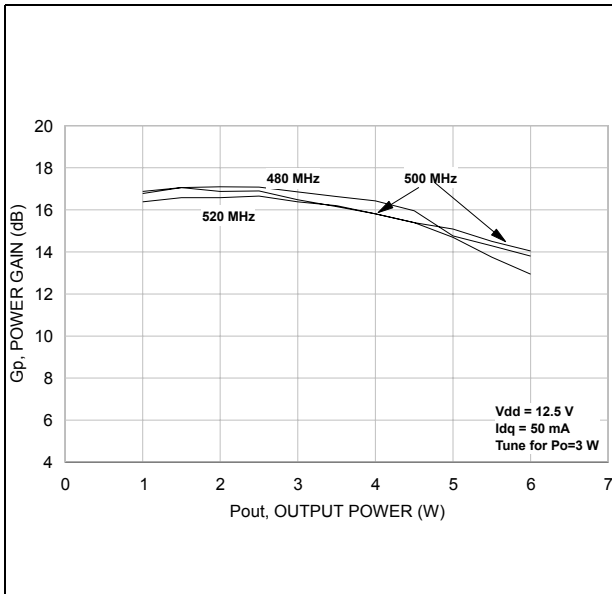

Figure 11. Return loss vs output power

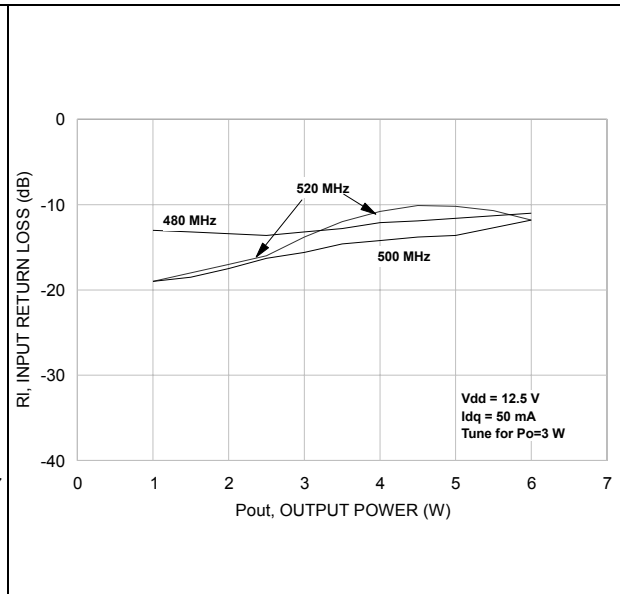

Figure 12. Output power vs bias current

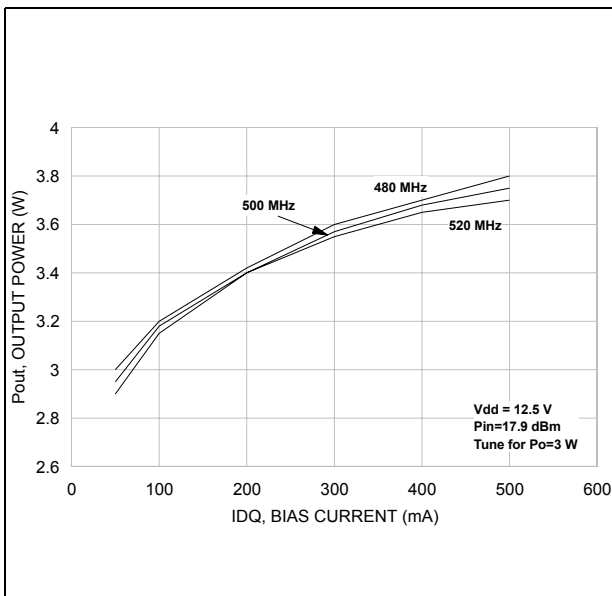
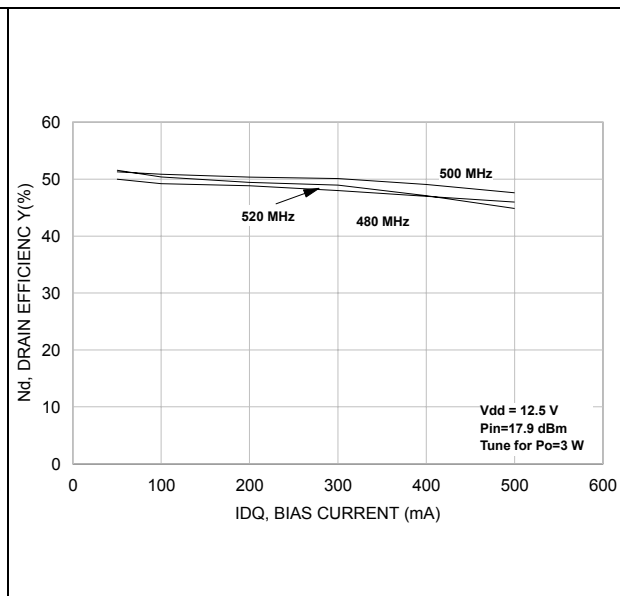

Figure 13. Drain efficiency vs bias current



PD55003

Figure 14. Output power vs supply voltage

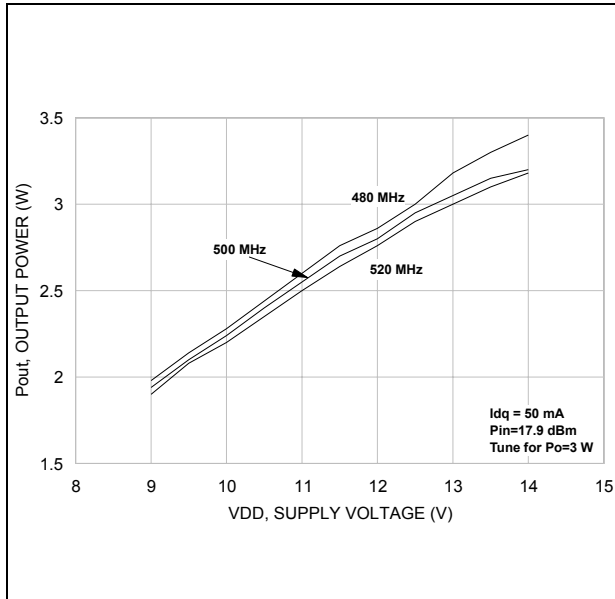

Table 7. Drain efficiency vs supply voltage

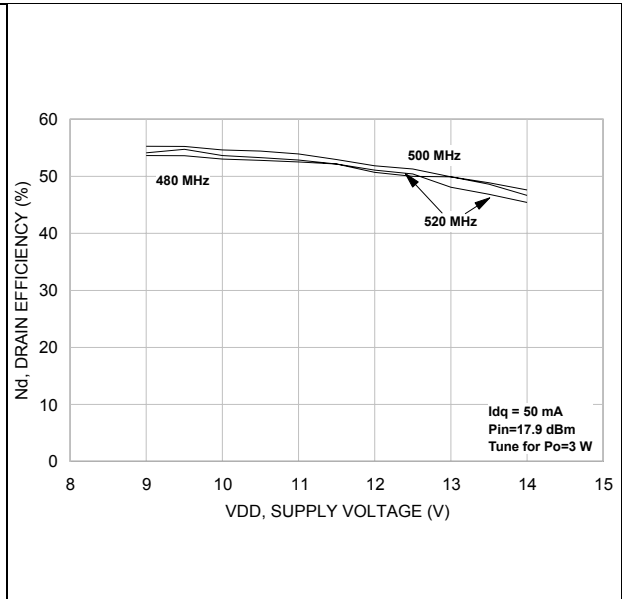
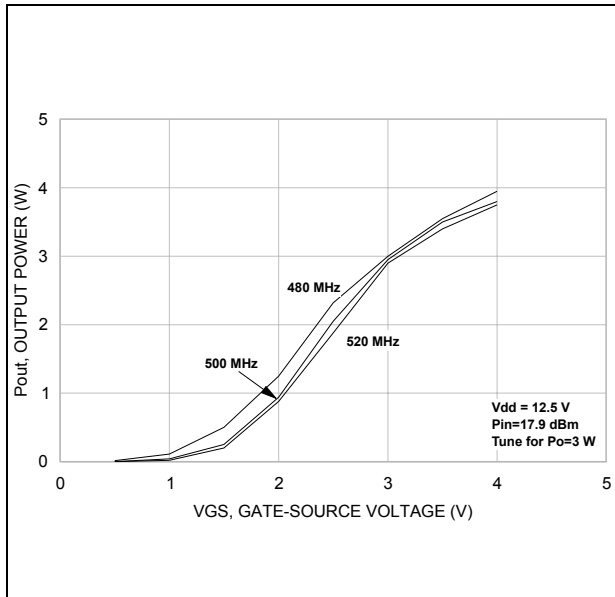

Figure 15. Output power vs gate voltage



PD55003S

Figure 16. Output power vs input power

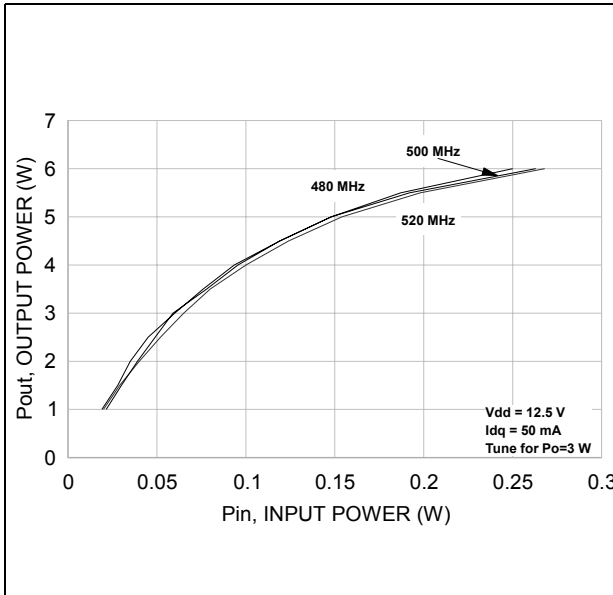

Figure 17. Output power vs input power

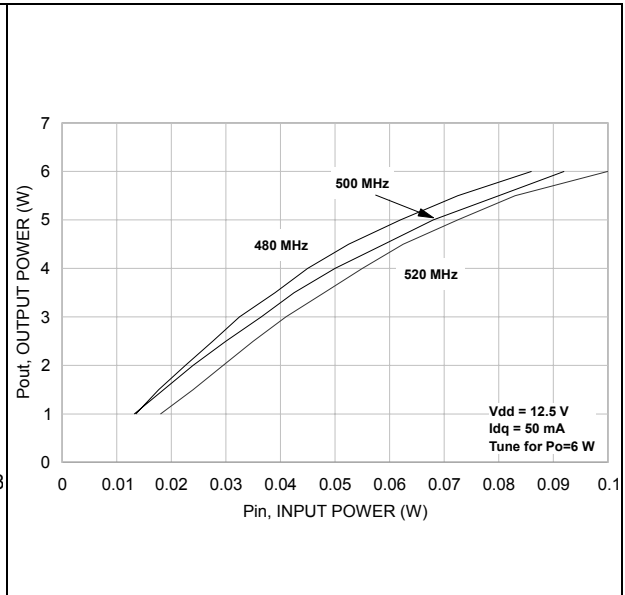

Figure 18. Drain efficiency vs output power

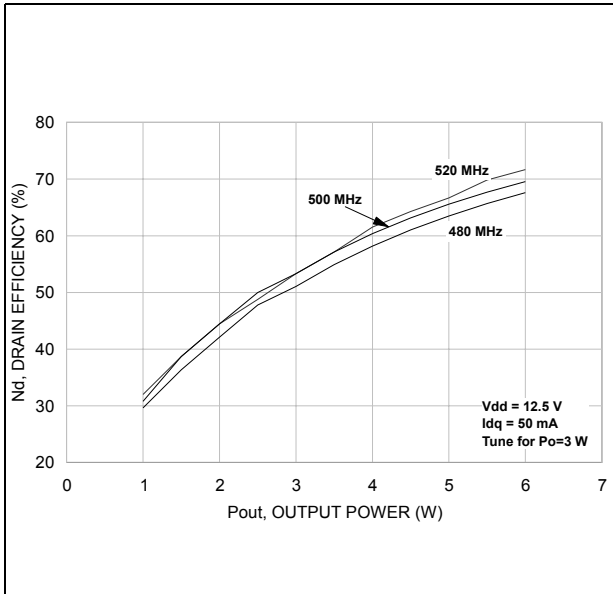
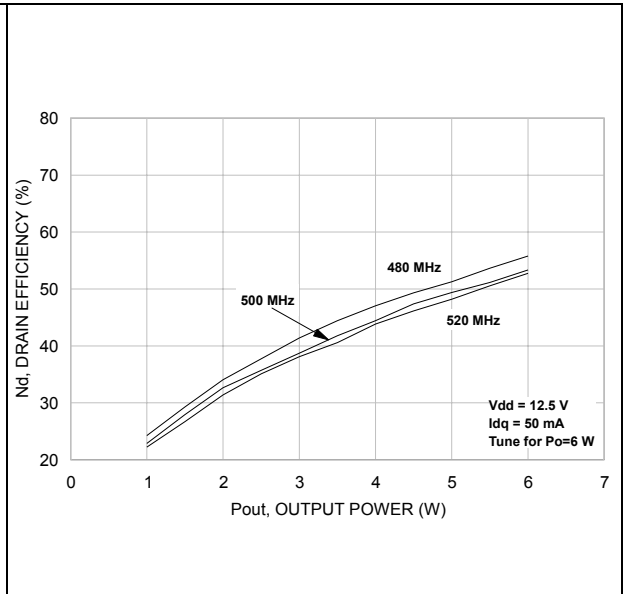

Figure 19. Drain efficiency vs output power



PD55003S

Figure 20. Power gain vs output power

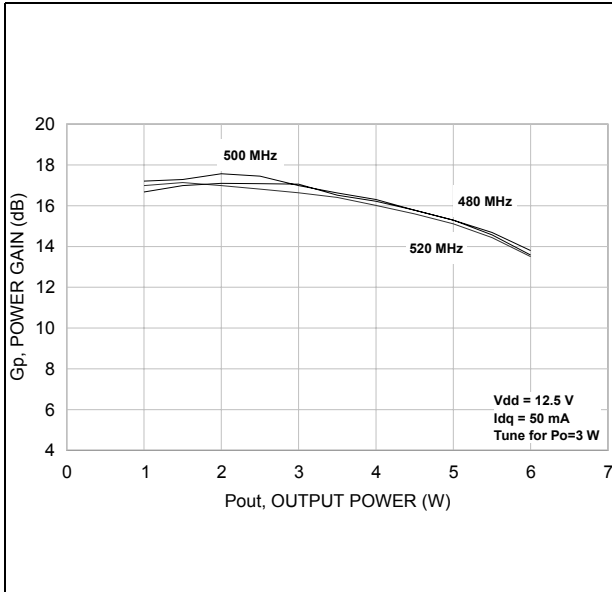

Figure 21. Return loss vs output power

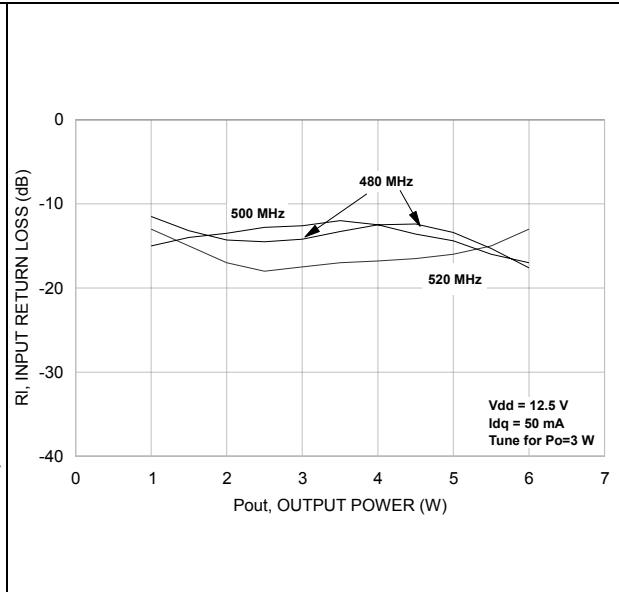

Figure 22. Output power vs bias current

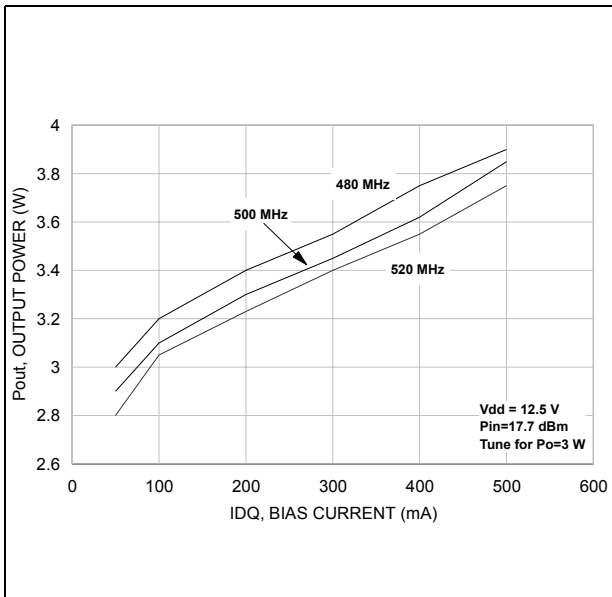
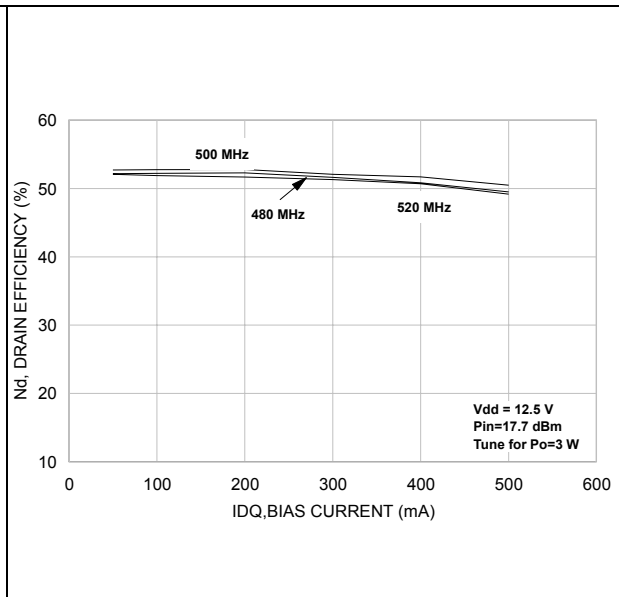

Figure 23. Drain efficiency vs bias current



PD55003S

Figure 24. Output power vs supply voltage

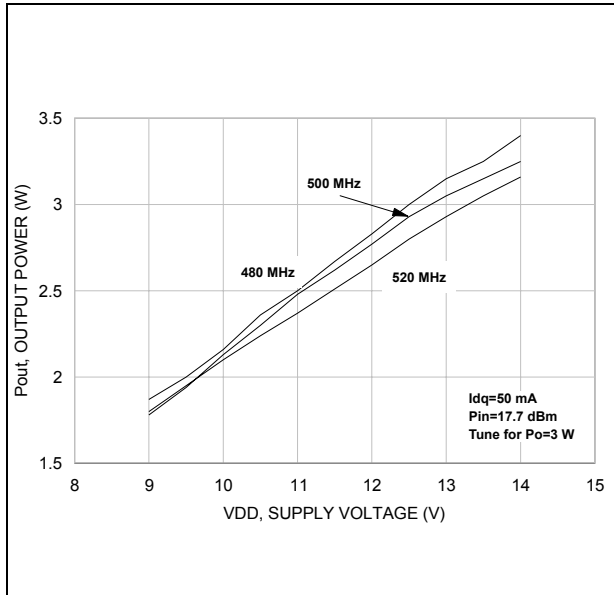

Figure 25. Drain efficiency vs supply voltage

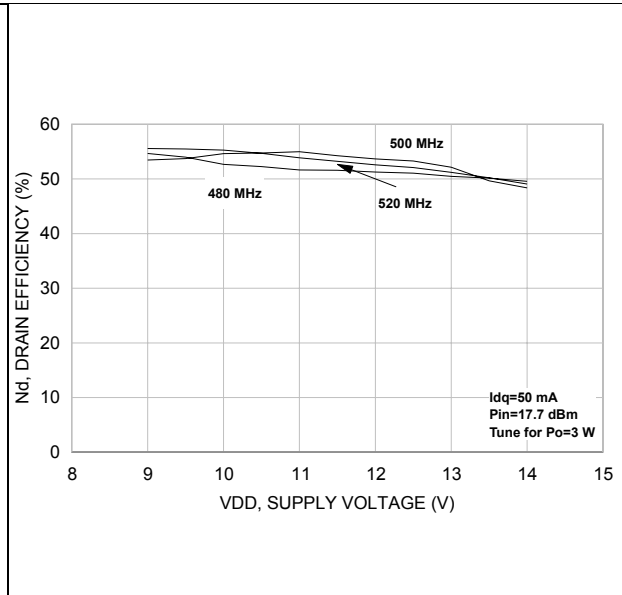
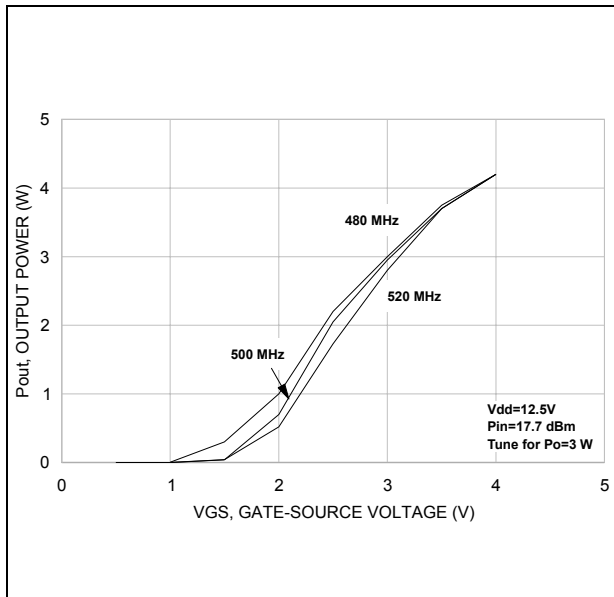

Figure 26. Output power vs gate voltage



5 Typical performance (860MHz)

PD55003

Figure 27. Output power vs input power

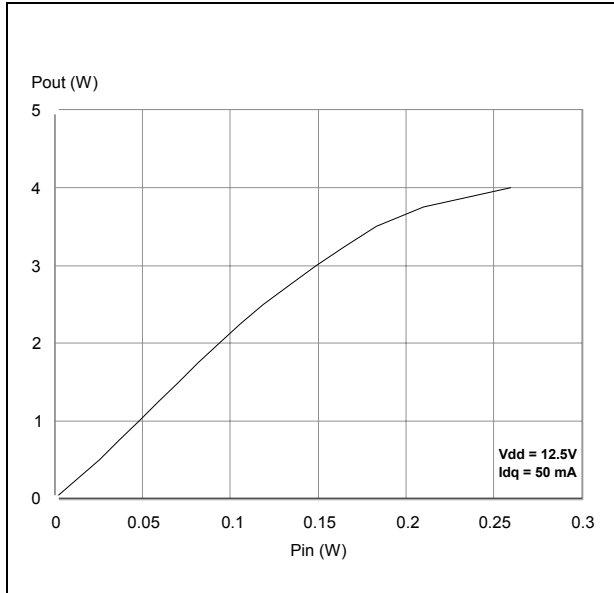

Figure 28. Drain efficiency vs output power

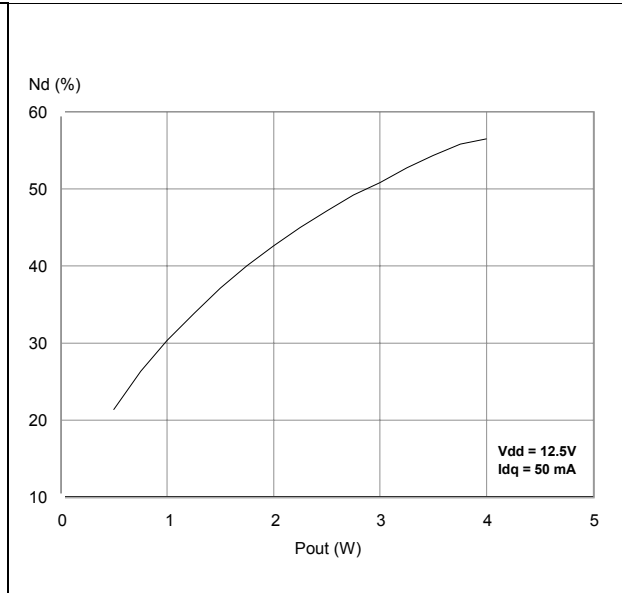
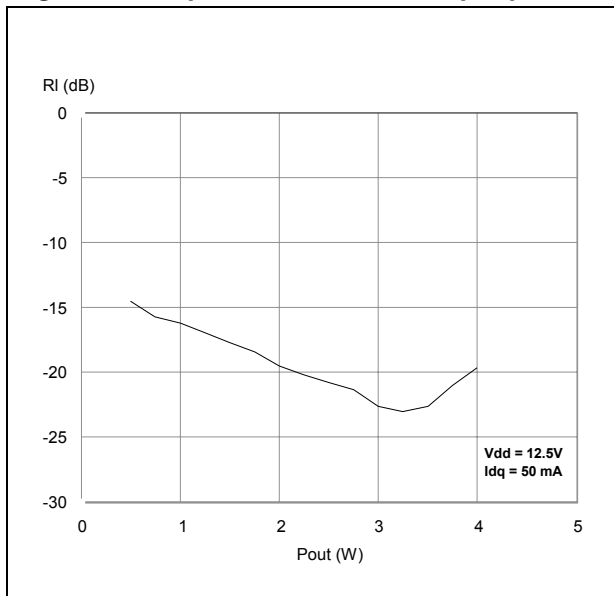

Figure 29. Input return loss vs output power



6 Test circuit

Figure 30. Test circuit schematic

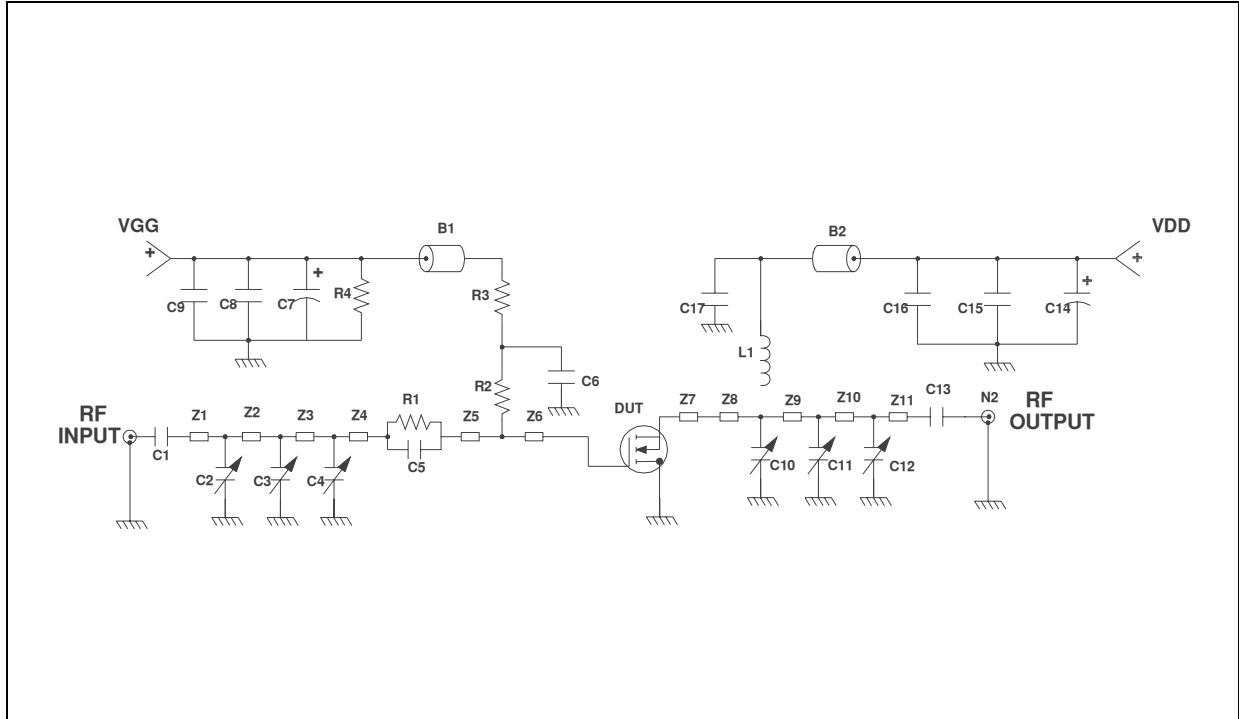

Table 8. Test circuit component part list

Component	Description
B1,B2	SHORT FERRIT BEAD, FAIR RITE PRODUCTS (2743021446)
C1,C14	240pf, 100 mil CHIP CAPACITOR
C2,C3,C4,C10,C11,C12	0 TO 20pf TRIMMER CAPACITOR
C5	130pf, 100 mil CHIP CAP
C6,C17	120pf, 100 mil CHIP CAP
C7,C14	10µf, 50V ELECTROLYTIC CAPACITOR
C8,C15	1.200pf, 100 mil CHIP CAP
C9,C16	0.1 F, 100 mil CHIP CAP
L1	55.5 nH, 5 TURN, COILCRAFT
N1,N2	TYPE N FLANGE MOUNT
R1	15 OHM, 0805 CHIP RESISTOR
R2	1.0 K OHM, 1/8 W RESISTOR
R3	15 OHM, 0805 CHIP RESISTOR
R4	33 K OHM, 1/8 W RESISTOR

Table 8. Test circuit component part list (continued)

Component	Description
Z1	0.175" X 0.080" MICROSTRIP
Z2	1.049" X 0.080" MICROSTRIP
Z3	0.289" X 0.080" MICROSTRIP
Z4	0.026" X 0.080" MICROSTRIP
Z5	0.192" X 0.223" MICROSTRIP
Z6,Z7	0.260" X 0.223" MICROSTRIP
Z8	0.064" X 0.080" MICROSTRIP
Z9	0.334" X 0.080" MICROSTRIP
Z10	0.985" X 0.080" MICROSTRIP
Z11	0.472" X 0.080" MICROSTRIP
BOARD	ROGER ULTRA LAM 2000 THK 0.030" $\epsilon_r = 2.55$ 2oz ED Cu BOTH SIDES

7 Circuit layout

Figure 31. Test fixture component layout

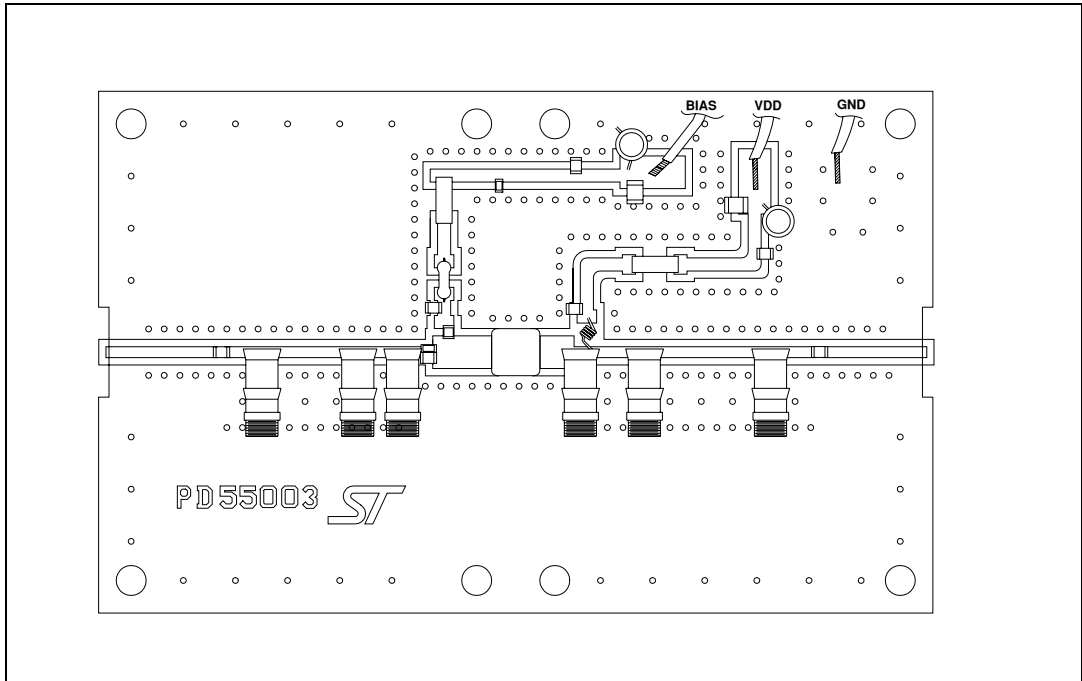
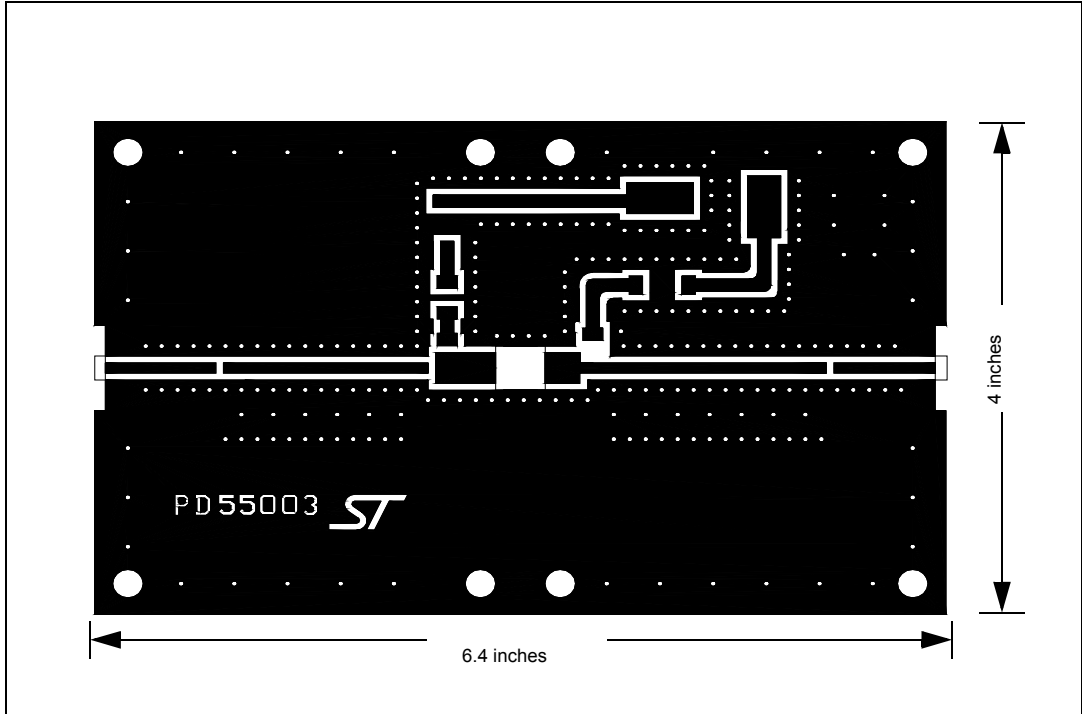

Figure 32. Test circuit photomaster



8 Common source s-parameter

8.1 PD55003 ($V_{DS} = 12.5V$ $I_{DS} = 0.15A$)

Table 9. S-parameter

Freq (MHz)	$ S_{11} $	$S_{11}\angle\Phi$	$ S_{21} $	$S_{21}\angle\Phi$	$ S_{12} $	$S_{12}\angle\Phi$	$ S_{22} $	$S_{22}\angle\Phi$
50	0.780	-120	21.77	106	0.038	19	0.669	-111
100	0.764	-144	11.34	88	0.040	-1	0.643	-137
150	0.786	-154	7.47	77	0.040	-10	0.634	-145
200	0.804	-159	5.45	69	0.037	-19	0.660	-149
250	0.817	-163	4.22	61	0.036	-26	0.680	-152
300	0.835	-165	3.36	55	0.034	-31	0.720	-156
350	0.852	-167	2.75	48	0.031	-36	0.766	-158
400	0.865	-169	2.28	43	0.028	-41	0.786	-160
450	0.877	-171	1.92	38	0.027	-45	0.816	-161
500	0.889	-172	1.65	34	0.025	-49	0.827	-163
550	0.899	-174	1.42	30	0.022	-52	0.847	-165
600	0.909	-175	1.24	27	0.021	-51	0.856	-167
650	0.918	-177	1.09	23	0.018	-56	0.874	-169
700	0.924	-178	0.97	20	0.018	-54	0.881	-170
750	0.926	-179	0.87	17	0.016	-61	0.895	-172
800	0.929	180	0.78	15	0.014	-62	0.906	-173
850	0.935	179	0.71	12	0.011	-56	0.916	-174
900	0.938	178	0.65	10	0.011	-63	0.913	-175
950	0.940	177	0.59	8	0.010	-62	0.925	-177
1000	0.941	176	0.55	5	0.007	-69	0.928	-178
1050	0.944	175	0.51	3	0.007	-57	0.925	-180
1100	0.947	174	0.47	1	0.006	-56	0.929	-180
1150	0.946	173	0.44	-1	0.005	-53	0.928	179
1200	0.944	172	0.41	-3	0.004	-40	0.927	178
1250	0.949	171	0.38	-5	0.004	-54	0.928	176
1300	0.949	170	0.36	-7	0.003	-63	0.940	176
1350	0.947	169	0.34	-9	0.001	-15	0.935	175
1400	0.949	168	0.31	-10	0.001	82	0.938	175
1450	0.946	167	0.29	-12	0.002	76	0.933	174
1500	0.948	167	0.27	-12	0.002	124	0.939	173

8.2 PD55003 ($V_{DS} = 12.5V$ $I_{DS} = 0.8A$)

Table 10. S-parameter

Freq (MHz)	$ S_{11} $	$S_{11}\angle\Phi$	$ S_{21} $	$S_{21}\angle\Phi$	$ S_{12} $	$S_{12}\angle\Phi$	$ S_{22} $	$S_{22}\angle\Phi$
50	0.786	-138	26.54	100	0.026	13	0.666	-137
100	0.791	-156	13.46	87	0.026	0	0.674	-155
150	0.816	-163	8.94	80	0.027	-5	0.662	-160
200	0.829	-167	6.63	73	0.026	-13	0.678	-163
250	0.835	-170	5.24	67	0.025	-16	0.677	-164
300	0.846	-171	4.26	62	0.025	-21	0.709	-167
350	0.854	-173	3.57	56	0.023	-25	0.736	-167
400	0.864	-174	3.01	51	0.021	-31	0.758	-168
450	0.872	-175	2.58	47	0.021	-31	0.783	-167
500	0.878	-176	2.24	43	0.019	-34	0.787	-168
550	0.890	-177	1.97	39	0.018	-37	0.800	-170
600	0.896	-178	1.74	36	0.017	-39	0.816	-171
650	0.902	-179	1.56	32	0.014	-44	0.827	-173
700	0.910	180	1.41	29	0.015	-38	0.845	-173
750	0.909	179	1.27	26	0.012	-46	0.854	-175
800	0.917	178	1.16	23	0.011	-41	0.865	-175
850	0.918	177	1.06	21	0.008	-37	0.879	-176
900	0.925	176	0.97	18	0.010	-43	0.877	-177
950	0.926	175	0.90	15	0.008	-47	0.887	-179
1000	0.927	174	0.83	12	0.007	-44	0.889	180
1050	0.921	173	0.77	10	0.007	-47	0.898	179
1100	0.932	172	0.72	8	0.006	-11	0.902	179
1150	0.933	172	0.67	6	0.005	-35	0.895	178
1200	0.930	171	0.63	4	0.004	-16	0.901	177
1250	0.937	170	0.59	1	0.004	-14	0.897	176
1300	0.937	169	0.55	-1	0.004	4	0.916	176
1350	0.936	168	0.52	-3	0.003	1	0.909	175
1400	0.937	168	0.49	-4	0.004	39	0.917	174
1450	0.934	167	0.45	-6	0.004	60	0.910	173
1500	0.938	166	0.43	-7	0.002	73	0.916	172

8.3 PD55003 ($V_{DS} = 12.5V$ $I_{DS} = 1.5A$)

Table 11. S-parameter

Freq (MHz)	$ S_{11} $	$S_{11}\angle\Phi$	$ S_{21} $	$S_{21}\angle\Phi$	$ S_{12} $	$S_{12}\angle\Phi$	$ S_{22} $	$S_{22}\angle\Phi$
50	0.789	-140	26.35	100	0.025	15	0.666	-141
100	0.800	-157	13.35	87	0.025	-1	0.675	-157
150	0.825	-164	8.88	80	0.024	-6	0.667	-162
200	0.836	-168	6.59	74	0.023	-13	0.678	-164
250	0.842	-171	5.22	68	0.024	-16	0.678	-165
300	0.851	-172	4.26	62	0.022	-18	0.713	-168
350	0.856	-174	3.56	57	0.021	-25	0.738	-168
400	0.864	-175	3.02	52	0.021	-28	0.754	-168
450	0.874	-176	2.60	48	0.019	-32	0.770	-168
500	0.882	-177	2.25	44	0.017	-32	0.782	-169
550	0.888	-178	1.98	40	0.016	-33	0.796	-171
600	0.898	-179	1.76	36	0.016	-37	0.806	-172
650	0.901	-180	1.58	33	0.013	-34	0.825	-173
700	0.909	179	1.42	30	0.013	-42	0.843	-174
750	0.910	178	1.29	27	0.011	-36	0.852	-175
800	0.915	177	1.18	24	0.012	-36	0.861	-176
850	0.915	177	1.08	21	0.010	-26	0.863	-176
900	0.922	176	0.99	19	0.009	-28	0.873	-178
950	0.926	175	0.92	16	0.008	-39	0.880	-179
1000	0.925	174	0.85	13	0.007	-39	0.882	180
1050	0.927	173	0.79	11	0.006	-27	0.892	179
1100	0.928	172	0.74	9	0.005	-35	0.891	178
1150	0.932	171	0.68	6	0.006	-11	0.899	178
1200	0.929	170	0.64	4	0.005	-20	0.896	177
1250	0.933	170	0.60	1	0.004	8	0.889	176
1300	0.935	169	0.57	0	0.005	15	0.907	175
1350	0.933	168	0.53	-3	0.004	25	0.904	174
1400	0.936	167	0.50	-4	0.003	53	0.911	174
1450	0.934	166	0.49	-6	0.004	53	0.909	173
1500	0.936	165	0.44	-7	0.004	64	0.914	172

8.4 PD55003S ($V_{DS} = 12.5V$ $I_{DS} = 0.15A$)

Table 12. S-parameter

Freq (MHz)	$ S_{11} $	$S_{11}\angle\Phi$	$ S_{21} $	$S_{21}\angle\Phi$	$ S_{12} $	$S_{12}\angle\Phi$	$ S_{22} $	$S_{22}\angle\Phi$
50	0.790	-120	22	107	0.038	17	0.682	-114
100	0.773	-145	11	89	0.039	-2	0.647	-138
150	0.791	-154	7	78	0.039	-9	0.640	-147
200	0.807	-159	5	70	0.037	-19	0.671	-151
250	0.820	-162	4	63	0.036	-23	0.691	-154
300	0.836	-164	3	56	0.033	-29	0.728	-156
350	0.850	-166	3	50	0.032	-33	0.751	-158
400	0.867	-167	2	45	0.030	-36	0.782	-160
450	0.880	-169	2	40	0.027	-43	0.808	-161
500	0.890	-170	2	36	0.024	-43	0.835	-163
550	0.902	-171	1	33	0.023	-50	0.845	-165
600	0.911	-172	1	29	0.022	-51	0.864	-166
650	0.919	-173	1	26	0.020	-55	0.872	-167
700	0.923	-174	1	23	0.018	-52	0.884	-169
750	0.924	-176	1	20	0.016	-55	0.887	-170
800	0.933	-177	1	18	0.015	-55	0.895	-172
850	0.936	-177	1	15	0.015	-56	0.912	-173
900	0.940	-178	1	13	0.012	-59	0.916	-174
950	0.943	-179	1	11	0.011	-53	0.926	-176
1000	0.944	-180	1	8	0.008	-60	0.943	-177
1050	0.949	180	1	7	0.007	-64	0.935	-177
1100	0.948	179	0	4	0.007	-44	0.944	-178
1150	0.950	178	0	3	0.006	-44	0.939	-179
1200	0.950	177	0	-1	0.005	-50	0.942	-180
1250	0.955	177	0	-2	0.004	-42	0.941	179
1300	0.951	176	0	-4	0.004	-41	0.933	178
1350	0.953	175	0	-5	0.004	-50	0.933	177
1400	0.953	175	0	-7	0.002	-41	0.947	176
1450	0.952	173	0	-9	0.002	-13	0.952	175
1500	0.949	173	0	-10	0.000	-3	0.958	174

8.5 PD55003S ($V_{DS} = 12.5V$ $I_{DS} = 0.8A$)

Table 13. S-parameter

Freq (MHz)	$ S_{11} $	$S_{11}\angle\Phi$	$ S_{21} $	$S_{21}\angle\Phi$	$ S_{12} $	$S_{12}\angle\Phi$	$ S_{22} $	$S_{22}\angle\Phi$
50	0.807	-137	26.18	102	0.025	12	0.682	-140
100	0.809	-156	13.41	88	0.026	0	0.683	-157
150	0.827	-163	8.92	81	0.025	-6	0.677	-162
200	0.838	-167	6.64	75	0.024	-12	0.698	-165
250	0.842	-169	5.24	69	0.026	-13	0.704	-166
300	0.849	-171	4.28	64	0.022	-19	0.720	-167
350	0.856	-172	3.57	59	0.023	-21	0.736	-167
400	0.866	-173	3.03	54	0.021	-28	0.758	-168
450	0.873	-174	2.61	50	0.020	-30	0.773	-168
500	0.881	-174	2.26	46	0.056	-27	0.797	-169
550	0.891	-175	1.99	42	0.018	-36	0.806	-170
600	0.896	-176	1.76	39	0.017	-35	0.825	-171
650	0.902	-176	1.58	36	0.016	-38	0.831	-171
700	0.908	-177	1.42	33	0.015	-39	0.834	-172
750	0.910	-178	1.29	30	0.014	-40	0.845	-174
800	0.916	-179	1.18	27	0.012	-43	0.859	-174
850	0.922	-180	1.08	25	0.011	-40	0.864	-175
900	0.926	180	1.00	22	0.009	-44	0.878	-176
950	0.927	179	0.93	19	0.010	-43	0.892	-178
1000	0.929	178	0.85	17	0.007	-34	0.905	-178
1050	0.937	178	0.80	15	0.007	-30	0.901	-179
1100	0.934	177	0.75	12	0.006	-29	0.910	-179
1150	0.934	177	0.70	10	0.006	-29	0.914	-180
1200	0.937	176	0.65	7	0.005	-23	0.912	180
1250	0.941	175	0.62	5	0.005	-25	0.912	179
1300	0.938	175	0.57	3	0.005	-3	0.909	177
1350	0.941	174	0.54	1	0.004	3	0.906	176
1400	0.941	174	0.51	-1	0.004	18	0.918	176
1450	0.939	173	0.48	-2	0.003	21	0.925	174
1500	0.939	172	0.45	-3	0.002	42	0.931	173

8.6 PD55003S ($V_{DS} = 12.5V$ $I_{DS} = 1.5A$)

Table 14. S-parameter

Freq (MHz)	$ S_{11} $	$S_{11}\angle\Phi$	$ S_{21} $	$S_{21}\angle\Phi$	$ S_{12} $	$S_{12}\angle\Phi$	$ S_{22} $	$S_{22}\angle\Phi$
50	0.816	-140	26.05	101	0.024	11	0.684	-144
100	0.817	-157	13.34	88	0.025	-2	0.690	-159
150	0.839	-164	8.89	82	0.024	-3	0.685	-164
200	0.847	-168	6.62	76	0.024	-10	0.701	-166
250	0.850	-170	5.25	70	0.023	-14	0.707	-168
300	0.655	-171	4.29	65	0.023	-17	0.726	-168
350	0.861	-173	3.59	60	0.021	-21	0.735	-169
400	0.869	-174	3.06	55	0.020	-24	0.761	-169
450	0.877	-174	2.64	51	0.019	-27	0.769	-170
500	0.884	-175	2.30	47	0.017	-31	0.795	-170
550	0.893	-176	2.02	44	0.017	-26	0.800	-171
600	0.898	-177	1.80	40	0.015	-36	0.819	-172
650	0.905	-177	1.62	38	0.015	-36	0.829	-172
700	0.908	-178	1.46	34	0.014	-34	0.831	-173
750	0.909	-179	1.33	31	0.012	-35	0.842	-174
800	0.914	-179	1.21	29	0.012	-36	0.852	-175
850	0.918	-180	1.11	26	0.011	-31	0.856	-176
900	0.923	179	1.03	23	0.009	-32	0.872	-177
950	0.927	179	0.96	21	0.009	-34	0.879	-178
1000	0.926	178	0.88	18	0.008	-21	0.894	-178
1050	0.935	178	0.83	16	0.007	-20	0.898	-179
1100	0.933	177	0.78	13	0.007	-22	0.900	-179
1150	0.933	176	0.73	10	0.006	-15	0.904	180
1200	0.934	175	0.68	8	0.005	-18	0.903	179
1250	0.940	175	0.64	6	0.004	-16	0.901	178
1300	0.935	174	0.59	4	0.004	4	0.902	177
1350	0.938	174	0.56	2	0.005	5	0.898	176
1400	0.938	173	0.53	0	0.005	25	0.915	175
1450	0.939	173	0.50	-2	0.004	14	0.925	174
1500	0.935	172	0.47	-3	0.002	48	0.928	173

9 Package mechanical data

In order to meet environmental requirements, ST offers these devices in ECOPACK® packages. These packages have a Lead-free second level interconnect . The category of second level interconnect is marked on the package and on the inner box label, in compliance with JEDEC Standard JESD97. The maximum ratings related to soldering conditions are also marked on the inner box label. ECOPACK is an ST trademark. ECOPACK specifications are available at: www.st.com

Table 15. PowerSO-10RF formed lead (Gull Wing) mechanical data

Dim.	mm.			Inch		
	Min	Typ	Max	Min	Typ	Max
A1	0	0.05	0.1	0.	0.0019	0.0038
A2	3.4	3.5	3.6	0.134	0.137	0.142
A3	1.2	1.3	1.4	0.046	0.05	0.054
A4	0.15	0.2	0.25	0.005	0.007	0.009
a		0.2			0.007	
b	5.4	5.53	5.65	0.212	0.217	0.221
c	0.23	0.27	0.32	0.008	0.01	0.012
D	9.4	9.5	9.6	0.370	0.374	0.377
D1	7.4	7.5	7.6	0.290	0.295	0.298
E	13.85	14.1	14.35	0.544	0.555	0.565
E1	9.3	9.4	9.5	0.365	0.37	0.375
E2	7.3	7.4	7.5	0.286	0.292	0.294
E3	5.9	6.1	6.3	0.231	0.24	0.247
F		0.5			0.019	
G		1.2			0.047	
L	0.8	1	1.1	0.030	0.039	0.042
R1			0.25			0.01
R2		0.8			0.031	
T	2 deg	5 deg	8 deg	2 deg	5 deg	8 deg
T1		6 deg			6 deg	
T2		10 deg			10 deg	

Note: Resin protrusions not included (max value: 0.15 mm per side)

Figure 33. Package dimensions

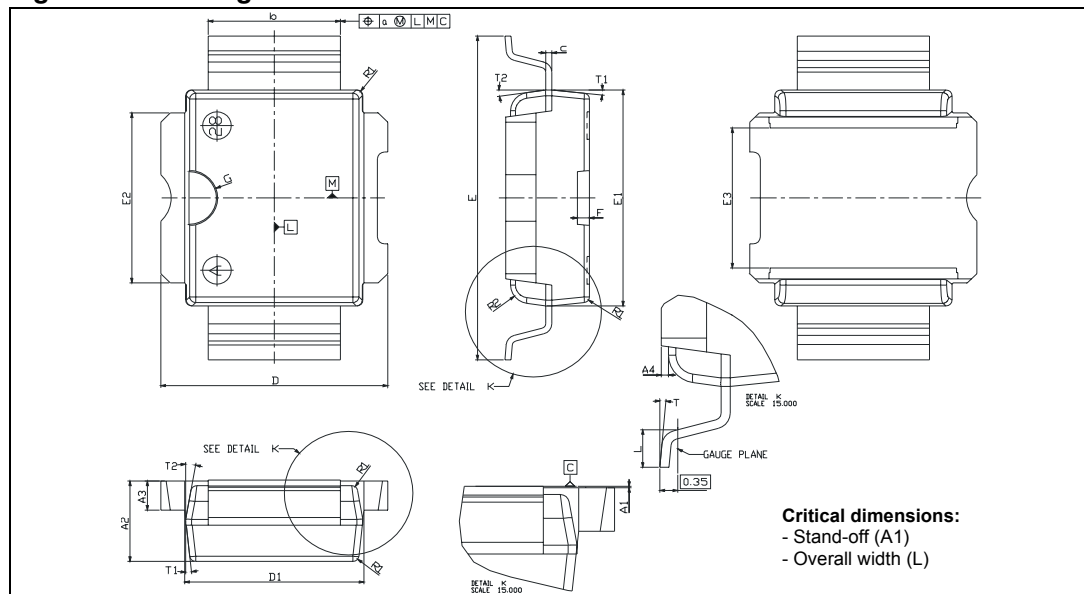

Table 16. PowerSO-10RF straight lead mechanical data

Dim.	mm.			Inch		
	Min	Typ	Max	Min	Typ	Max
A1	1.62	1.67	1.72	0.064	0.065	0.068
A2	3.4	3.5	3.6	0.134	0.137	0.142
A3	1.2	1.3	1.4	0.046	0.05	0.054
A4	0.15	0.2	0.25	0.005	0.007	0.009
a		0.2			0.007	
b	5.4	5.53	5.65	0.212	0.217	0.221
c	0.23	0.27	0.32	0.008	0.01	0.012
D	9.4	9.5	9.6	0.370	0.374	0.377
D1	7.4	7.5	7.6	0.290	0.295	0.298
E	15.15	15.4	15.65	0.595	0.606	0.615
E1	9.3	9.4	9.5	0.365	0.37	0.375
E2	7.3	7.4	7.5	0.286	0.292	0.294
E3	5.9	6.1	6.3	0.231	0.24	0.247
F		0.5			0.019	
G		1.2			0.047	
R1			0.25			0.01
R2		0.8			0.031	
T1		6 deg			6 deg	
T2		10 deg			10 deg	

Note: Resin protrusions not included (max value: 0.15 mm per side)

Figure 34. Package dimensions

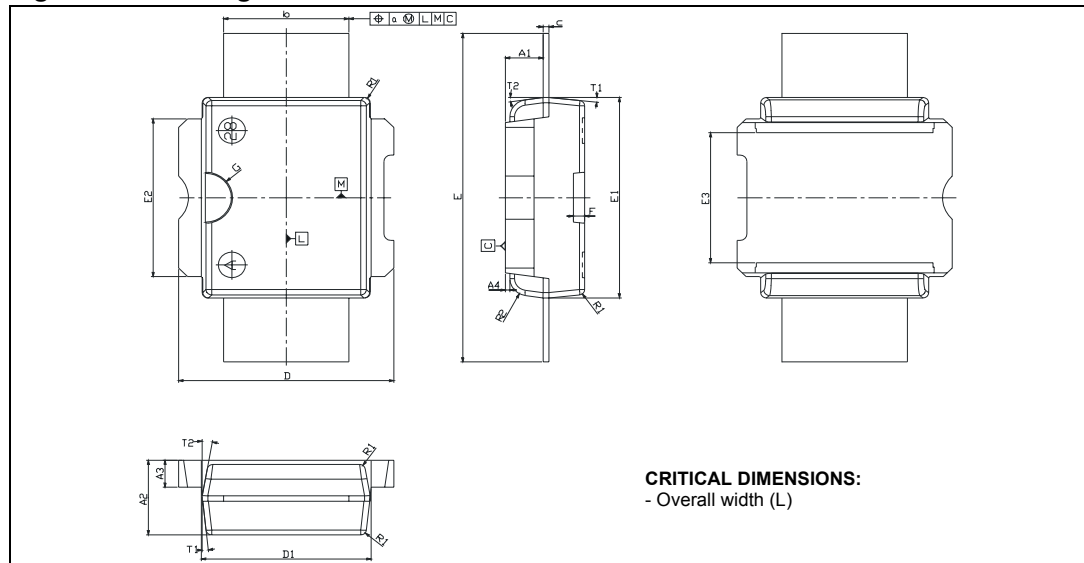

Figure 35. Tube information

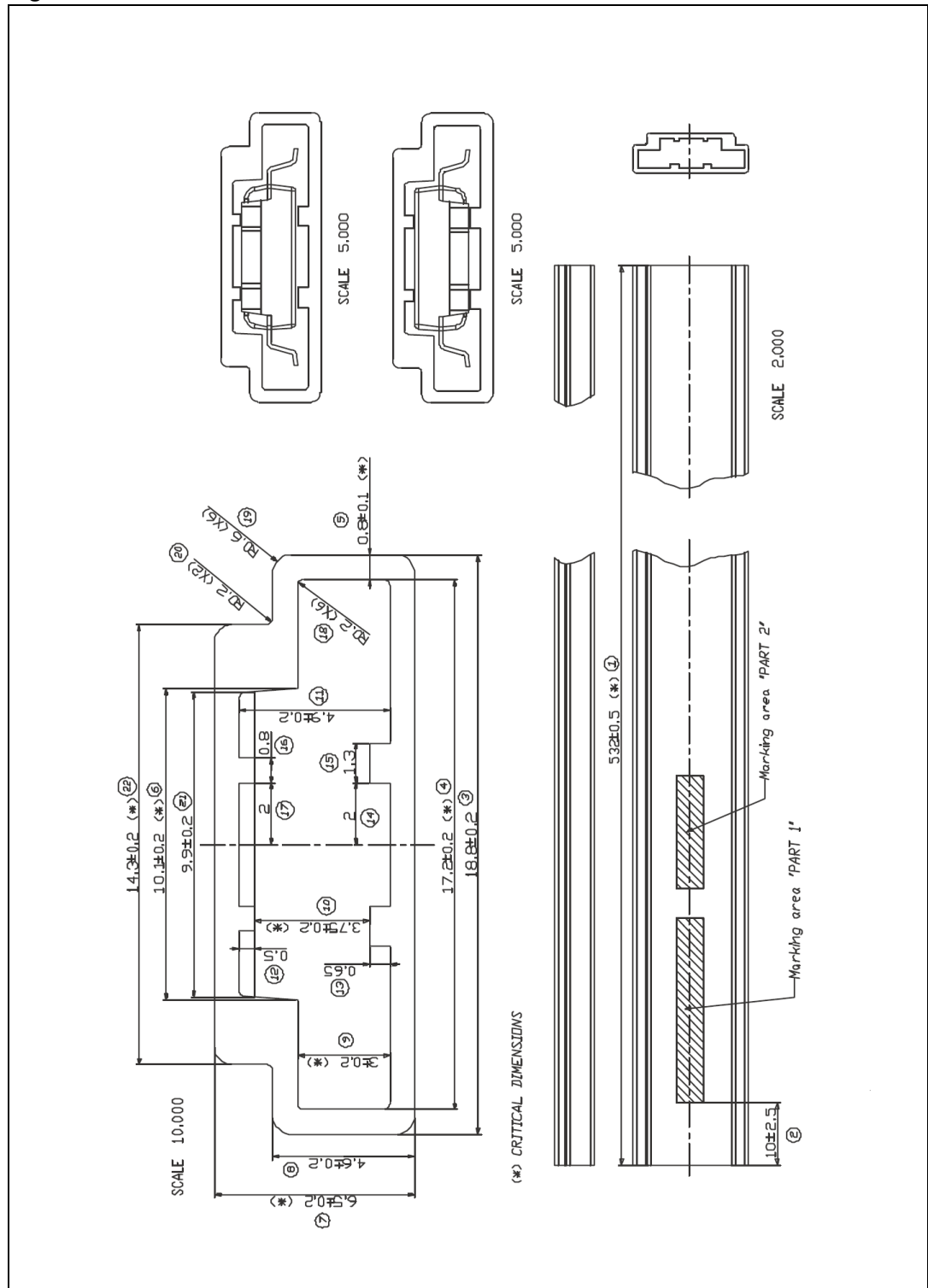
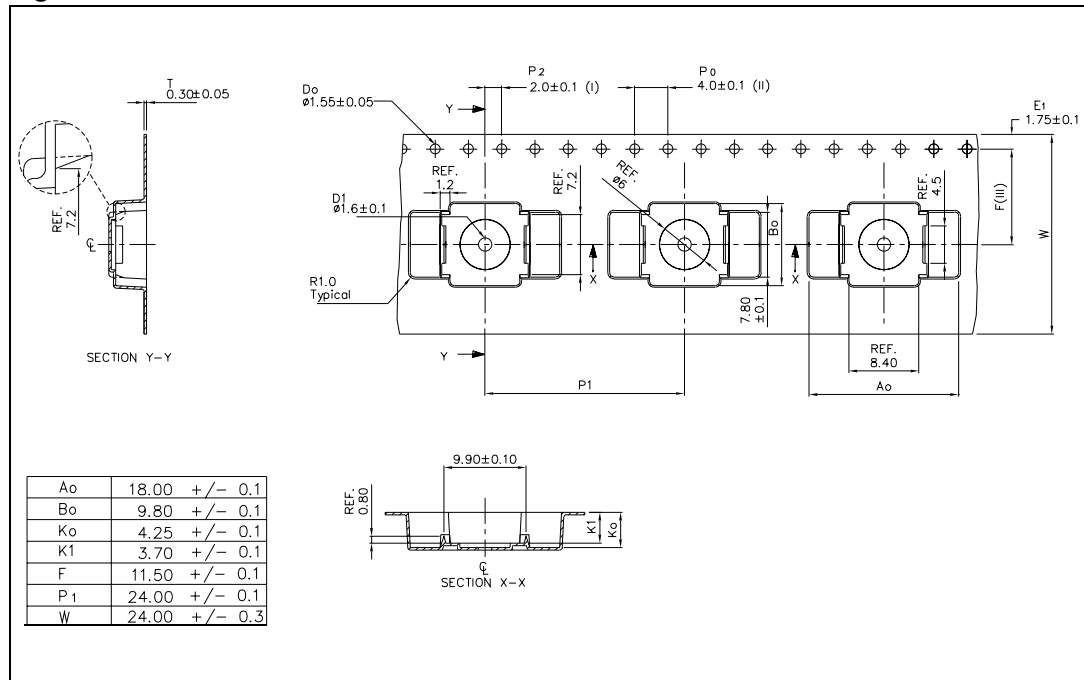

Figure 36. Reel information



10 Revision history

Table 17. Document revision history

Date	Revision	Changes
05-Apr-2006	1	Initial release.
01-Aug-2007	2	Update $R_{DS(ON)}$ in Table 4 on page 6 .

Please Read Carefully:

Information in this document is provided solely in connection with ST products. STMicroelectronics NV and its subsidiaries ("ST") reserve the right to make changes, corrections, modifications or improvements, to this document, and the products and services described herein at any time, without notice.

All ST products are sold pursuant to ST's terms and conditions of sale.

Purchasers are solely responsible for the choice, selection and use of the ST products and services described herein, and ST assumes no liability whatsoever relating to the choice, selection or use of the ST products and services described herein.

No license, express or implied, by estoppel or otherwise, to any intellectual property rights is granted under this document. If any part of this document refers to any third party products or services it shall not be deemed a license grant by ST for the use of such third party products or services, or any intellectual property contained therein or considered as a warranty covering the use in any manner whatsoever of such third party products or services or any intellectual property contained therein.

UNLESS OTHERWISE SET FORTH IN ST'S TERMS AND CONDITIONS OF SALE ST DISCLAIMS ANY EXPRESS OR IMPLIED WARRANTY WITH RESPECT TO THE USE AND/OR SALE OF ST PRODUCTS INCLUDING WITHOUT LIMITATION IMPLIED WARRANTIES OF MERCHANTABILITY, FITNESS FOR A PARTICULAR PURPOSE (AND THEIR EQUIVALENTS UNDER THE LAWS OF ANY JURISDICTION), OR INFRINGEMENT OF ANY PATENT, COPYRIGHT OR OTHER INTELLECTUAL PROPERTY RIGHT.

UNLESS EXPRESSLY APPROVED IN WRITING BY AN AUTHORIZED ST REPRESENTATIVE, ST PRODUCTS ARE NOT RECOMMENDED, AUTHORIZED OR WARRANTED FOR USE IN MILITARY, AIR CRAFT, SPACE, LIFE SAVING, OR LIFE SUSTAINING APPLICATIONS, NOR IN PRODUCTS OR SYSTEMS WHERE FAILURE OR MALFUNCTION MAY RESULT IN PERSONAL INJURY, DEATH, OR SEVERE PROPERTY OR ENVIRONMENTAL DAMAGE. ST PRODUCTS WHICH ARE NOT SPECIFIED AS "AUTOMOTIVE GRADE" MAY ONLY BE USED IN AUTOMOTIVE APPLICATIONS AT USER'S OWN RISK.

Resale of ST products with provisions different from the statements and/or technical features set forth in this document shall immediately void any warranty granted by ST for the ST product or service described herein and shall not create or extend in any manner whatsoever, any liability of ST.

ST and the ST logo are trademarks or registered trademarks of ST in various countries.

Information in this document supersedes and replaces all information previously supplied.

The ST logo is a registered trademark of STMicroelectronics. All other names are the property of their respective owners.

© 2007 STMicroelectronics - All rights reserved

STMicroelectronics group of companies

Australia - Belgium - Brazil - Canada - China - Czech Republic - Finland - France - Germany - Hong Kong - India - Israel - Italy - Japan - Malaysia - Malta - Morocco - Singapore - Spain - Sweden - Switzerland - United Kingdom - United States of America

www.st.com

